

1-Channel circuit breaker current-limiting, communicative **EB-1824-020-0**



EasyB

Advantages

Automatic channel assignment
Communication via communication modules
Optional undervoltage shutdown in combined network
Optional settings for tripping current
Additional load outputs through output expanders mountable sidewise
Selective load-dependent activation
Common reset input
3 years warranty

Applications

Electronic circuit breaker with current-limiting characteristic and comprehensive communication with the connected modules. Suitable as advanced fuse for 24 V loads with option of reading more detailed current supply parameters and actively controlling the channels.

Standards

Safety:
EN 60950-1, EN 50178, EN/IEC 60204-1
EMC:
EN 61000-6-2 (interference immunity), EN 61000-6-3 (emitted interference)
CE:
Acc. to 2014/30/EU

Approvals



UL 508, UL 2367, DNV GL,
VW eCl@ss No.27-37-18-02 (prepared)



1-Channel circuit breaker current-limiting, communicative EB-1824-020-0

Type	EB-1824-020-0
Electrical data	
Special features	
Characteristics	Preset tripping currents
Input	
Input rated voltage	24 Vdc
Input voltage range	18 - 30 Vdc
Maximal residual ripple of supplied input voltage	3 %
Max. total input current	2 A
Max. input current for each pole of terminal	10 A (-), 40 A (+)
Required input voltage for turning-on of outputs	17.5 Vdc (Turn-off Threshold 16.7 Vdc), ± 0.7 Vdc
Max. power losses	1,3 W
Over voltage protection	Suppressor diode 33 Vdc
Stand-by current	39 mA @ 24 Vdc
Power losses in stand-by mode	1,17 W @ 24 Vdc
Turn on capacity	130 mF @ 24 Vdc / 2,5 mm ² / 2,5 m
Output	
Output rated voltage	24 Vdc
Maximum voltage drop between input and output	55 mV
Initialization time of module	52 ms
Turn-on delay of outputs	min. 50 ms / max. 5 s
Waiting periode after switch-off of an output	500 ms (Short circuit) . . 5 s (Overload)
Parallel use of outputs	Not allowed
Serial use of outputs	Not allowed
Resistance to reverse feed max.	35 Vdc
Output rated current	2 A
Efficiency	99 %
Output limited current	typ. 2,5 A
Signaling	
Bus communication	Read:-state (tripped, On, Off) -set/active current -input voltage -firmware version/serial number Write:-state (on, off, reset)
Status indicator	LED (red, green, orange)
Signal output	Output status, short circuit proof high = Channel on, low = Channel off, fault Reset input
Signal output (ON/OFF/Reset)	Level high = min. 15 Vdc, max. 30 Vdc Level low = min. 0 Vdc, max. 5 Vdc
Environment	
Type of cooling	Natural convection
Ambient temperature	-25 °C to +70 °C
Storage temperature	-13 °F . . +185 °F
Derating	-
Relative humidity	5 . . 96 %, without condensation
Required minimum spacing (left/right)	0.00 inch
Required minimum spacing (over/under)	1.18 inch
Safety and protection	
Protection index	IP 20
Safety class	III, without PE connection
Degree of pollution	2
Order numbers	
Order Number	EB-1824-020-0

Type	EB-1824-020-0
Mechanical data	
Terminal and mounting	
Terminals input, (spring clamp terminal)	max. 16 mm ²
Terminals output, (spring clamp terminal)	max 2,5 mm ² (1 x "+")
Terminals signalling, (spring clamp terminal)	max. 2,5 mm ²
Mounting position	horizontal for standard rail DIN TS35
Measures and weights	
Weight	0.09 lbs
Dimensions in inch	

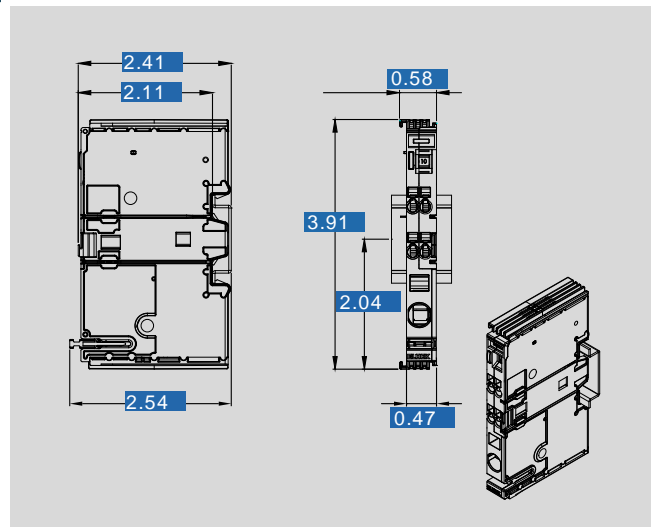

Subject to change.