

Harmonic filter HF1P 4,60-230



Advantages

Sinusoidal current consumption from the main in devices with uncontrolled B2U diode rectifiers
Compliance with EN 61000-3-2, EN 61000-3-12
Support in the compliance with IEEE 519, D-A-CH-CZ
Power factor >0,95 at rated current
Operation at 50 - 60 Hz possible
Use of the HF1P as a central sum filter for multiple converters possible

Applications

Harmonic filter module to ensure sinusoidal main currents, reduction of main harmonic currents, increase in system service life and system reliability and compliance with power quality standards such as IEEE 519, TEC 61000-3-2, IEC 61000-3-12.

Standards

Harmonic filter in accordance with
EN 61558 Part 1, EN 61558 Part 20, UL 508 17th Ed., CSA 22.2 No. 14-10

Approvals





Harmonic filter HF1P 4,60-230

Type	HF1P 4,60-230
Electrical data	
Operating data	
Rated voltage	230 Vac
Voltage range	207-253 Vac
Rated current	20.00 A
THD-I	10 % at 50 Hz, 18 % at 60 Hz (nominal load)
Rated load power	6.17 HP
Description of the load	Symmetrical loading by converters with B2U input rectifiers
Oversrating Capacity	150 % for 60 sec. every 10 min.
Efficiency	98.2 %
Power loss	80 W
Capacitive idle power	3.3 kVAr
Input	
Rated frequency	50 - 60 Hz
Environment	
Ambient temperature	14 °F to 104 °F, without condensation
Type of cooling	Air natural
MTBF @ 122 °F/500 V (Mil-HB-217F)	>500.000 h @ 40°C/400Vac
Safety and protection	
Type	Metal enclosure
Insulation class	H
Protection index	IP 20
Safety class	I
Notes	
*	IE2 efficiencies of the motors and an efficiency >96 % assumed
Order numbers	
Order Number	HF1P 4,60-230

Type	HF1P 4,60-230
Mechanical data	
Terminal and mounting	
Terminals phase	Screw clamp, 16 mm ²
Connection type	Bolt, M6
Fixing method	Mounting lugs
Measures and weights	
Weight	48.94 lbs

Dimensions in inch

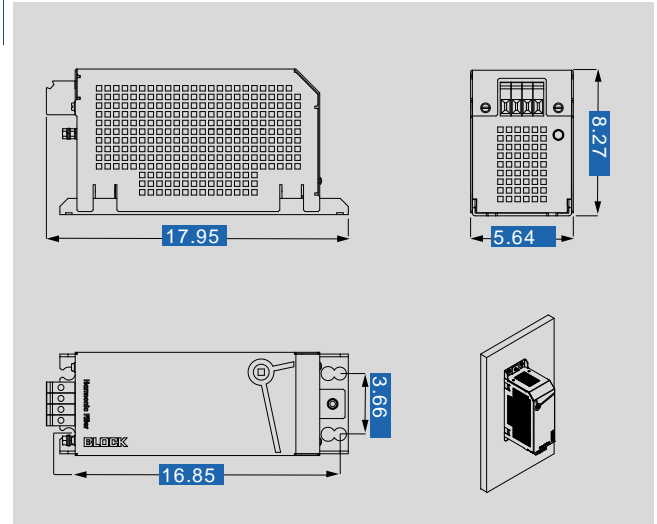

Subject to change.