

Line reactor, single-phase **NKE 16/3,19**



Picture shows NKE 25/2,04

Advantages

Use as line reactor, commutating reactor or PFC reactor
Power harmonic damping
Starting current limitation
Increases the service life of equipment
Low ripple
Very good corrosion protection and low noise due to vacuum impregnation
Bridging voltage dips
Peak current limitation

Applications

Line reactor to minimize mains pollution, to reduce the reactive-power components and charging currents in the DC link capacitor and to improve the $\cos(\phi)$.

Standards

Line- and commutation reactor to
DIN EN 61558-2-20, IEC 61558-2-20, UL 506, CSA 22.2

Approvals



UL 506, CSA 22.2



Line reactor, single-phase NKE 16/3,19

Type		NKE 16/3,19
Electrical data	Operating data	
	Rated voltage	max. 400 Vac
	Voltage drop	16 Vac
	Rated current	16 A
	Rated frequency	50 - 60 Hz
	Inductance	3.19 mH
	Inductance deviation	±10%
	Approvals	
	Approvals	cURus
	Environment	
	Ambient temperature	14 °F to +104 °F
	Type of cooling	AN
	Safety and protection	
Insulation class	B	
Protection index	IP 00	
Safety class (prepared)	I	
Type	Open type	
Test voltage	2500 Vac	
Order numbers		
Order Number	NKE 16/3,19	

Type		NKE 16/3,19
Mechanical data	Terminal and mounting	
	Terminals phase	Screw clamp, 4 mm ²
	Connection type	Tab connector, 6.3 x 0.8 mm
	Fixing method	Base plate
	Fixing screws	M5
Measures and weights		
Weight	4.85 lbs	

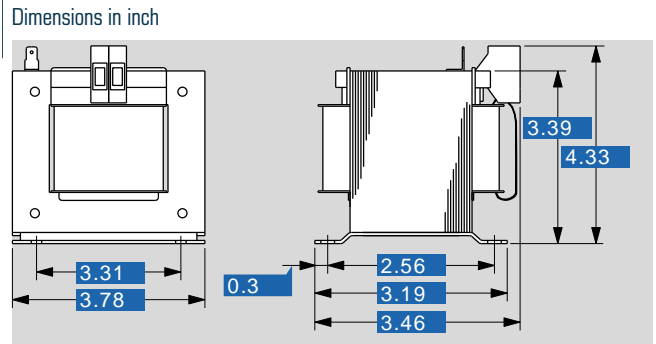

Subject to change.