

Control- and safety isolating transformer ST 250/23/24



Picture shows ST 160/23-23

Advantages

Reduced inrush current
High power density due to a compact construction design
Primary side $\pm 5\%$ taps for voltage adjustment
Very good corrosion protection and low noise due to vacuum impregnation
Contact protected screw connection terminals complying with UVV BGV A3
Simple mounting due to robust metal footplate with oval slots

Applications

As a control transformer for the electrical isolation of the input and output sides. The construction of the transformer to supply control systems according to VDE 0113 is designed.

As an isolating transformer for the safe electrical isolation of the input and output sides. The transformer may be used to set up protective separation as a protective measure in accordance with VDE 0100.

As a safety isolating transformer for the safe electrical isolation of the input and output sides. The transformer is suitable for creating SELV and PELV circuits because of the limit on the output voltage.

Sample application



Standards

Control transformer
to: VDE 0570 Teil 2-2, DIN EN 61558-2-2, EN 61558-2-2, IEC 61558-2-2,
UL 5085-1/-2, CSA 22.2 No.66
Safety isolating transformer
to: VDE 0570 Teil 2-6, DIN EN 61558-2-6, EN 61558-2-6, IEC 61558-2-6, UL
5085-1/-2, CSA 22.2 No.66

Approvals



VDE, UL 5085-1/-2, CSA 22.2 No.66



Control- and safety isolating transformer ST 250/23/24

Type		ST 250/23/24
Electrical data	Input	
	Rated input voltage	230 Vac
	Tappings Input	±5 %
	Rated frequency	50 - 60 Hz
	Output	
	Rated output voltage	24 Vac
	Rated power VDE (DB cos phi=1)	250 VA
	Rated power VDE (KB cos phi=0,5)	555 VA
	No-load voltage (app. x factor)	1.08
	Efficiency	90 %
	UL Derating	200 VA
	Standards	
	Classification	Control- and safety isolating transformer
	Approvals	
	Approvals	cURus, VDE
	Environment	
	Ambient temperature max.	104,0 °F
	Type of cooling	by self-cooling
	Safety and protection	
	Type	Open type
Insulation class	VDE=B, UL=class 105	
Protection index	IP 00	
Safety class (prepared)	I	
Short circuit strength	non-short-circuit proof	
PRI Fusing recommendation by circuit breaker with tripping characteristic type 20 x Irated related to set)		
Setting range	1.00 - 1.60 A	
Setting value	1.2 A	
Order numbers		
Order Number	ST 250/23/24	

Type		ST 250/23/24
Mechanical data	Terminal and mounting	
	Terminals	Screw-type terminals, PE 6.3 x 0.8
	Fixing method	Base plate
	Fixing screws	M5
	Measures and weights	
	Weight	7.72 lbs

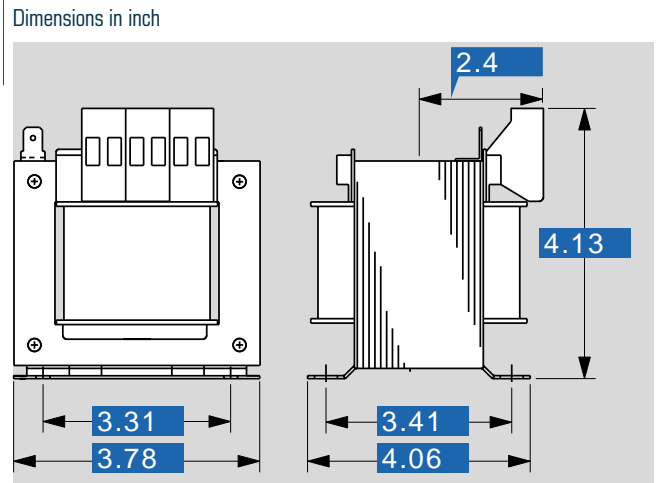

Subject to change.