

# Control- and isolating transformer STU 1000/2x115



Picture shows STU 160/24

## Advantages

Universal input voltages 210 to 540 Vac
Reduced inrush current
High power density due to a compact construction design
Very good corrosion protection and low noise due to vacuum impregnation
Contact protected screw connection terminals complying with UVV BGV A3
Simple mounting due to robust metal footplate with oval slots

## Applications

As a control transformer for the electrical isolation of the input and output sides. The construction of the transformer to supply control systems according to VDE 0113 is designed.

As an isolating transformer for the safe electrical isolation of the input and output sides. The transformer may be used to set up protective separation as a protective measure in accordance with VDE 0100.

As a safety isolating transformer for the safe electrical isolation of the input and output sides. The transformer is suitable for creating SELV and PELV circuits because of the limit on the output voltage.

## Sample application

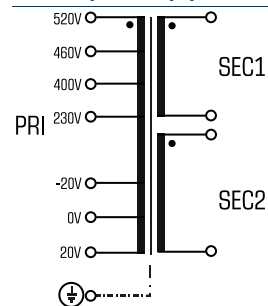

## Standards

Control transformer  
to: VDE 0570 Teil 2-2, DIN EN 61558-2-2, EN 61558-2-2, IEC 61558-2-2,  
UL 5085-1/-2, CSA 22.2 No.66  
Isolating transformer  
to: VDE 0570 Part 2-4, DIN EN 61558-2-4, EN 61558-2-4, IEC 61558-2-4,  
UL 5085-1/-2, CSA 22.2 No.66

## Approvals



VDE, UL 5085-1/-2, CSA 22.2 No.66



# Control- and isolating transformer STU 1000/2x115

Type	STU 1000/2x115
<b>Electrical data</b>	
<b>Input</b>	
Rated input voltage	210 Vac/230 Vac/250 Vac/ 380 Vac/400 Vac/420 Vac/ 440 Vac/460 Vac/480 Vac/ 500 Vac/520 Vac/540 Vac
Rated frequency	50 - 60 Hz
<b>Output</b>	
Rated output voltage	2 x 115 Vac
Rated power VDE (DB cos phi=1)	1,000 VA
Rated power VDE (KB cos phi=0.5)	3,120 VA
No-load voltage (app. x factor)	1.03
Efficiency	94 %
UL Derating	800 VA
<b>Standards</b>	
Classification	Control- and isolating transformer
<b>Approvals</b>	
Approvals	cURus, VDE
<b>Environment</b>	
Ambient temperature max.	104,0 °F
Type of cooling	by self-cooling
<b>Safety and protection</b>	
Type	Open type
Insulation class	VDE=B, UL=class 105
Protection index	IP 00
Safety class (prepared)	I
Short circuit strength	non-short-circuit proof
PRI Fusing recommendation by circuit breaker with tripping characteristic type 20 x I <sub>rated</sub> related to set)	
Setting range 230 ±20 Vac	4.00 - 6.30 A
Setting value 230 ±20 Vac	4.6 A
Setting range 400 ±20 Vac	2.50 - 4.00 A
Setting value 400 ±20 Vac	2.6 A
Setting range 460 ±20 Vac	1.60 - 2.50 A
Setting value 460 ±20 Vac	2.3 A
Setting range 520 ±20 Vac	1.60 - 2.50 A
Setting value 520 ±20 Vac	2 A
<b>Order numbers</b>	
<b>Order Number</b>	<b>STU 1000/2x115</b>

Type	STU 1000/2x115
<b>Mechanical data</b>	
<b>Terminal and mounting</b>	
Fixing method	Base plate
Fixing screws	M6
Terminals	Screw-type terminals, PE 6.3 x 0.8
<b>Measures and weights</b>	
Weight	29.76 lbs

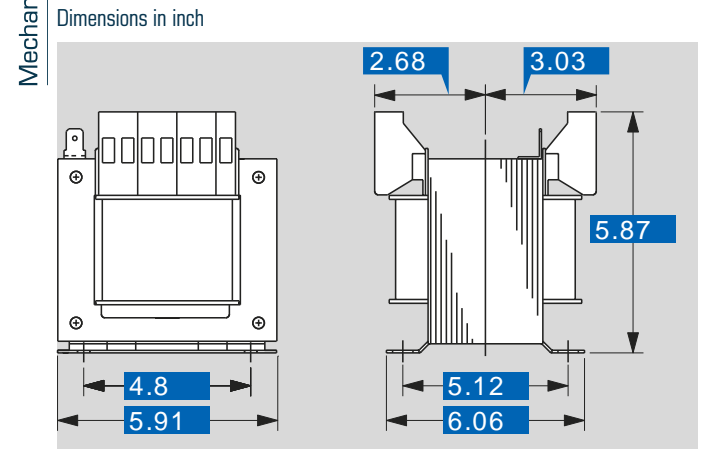

Subject to change.