

Control- and isolating transformer TT1 1-4-23



Picture shows TT1 20-4/23

Advantages

Safe galvanic isolation
Patented assembly technology
Very good corrosion protection and low noise due to vacuum impregnation
Primary side $\pm 5\%$ taps for voltage adjustment
Fixed, contact protected screw connection terminals complying with UVV BGV A3
Multiple mounting dimensions
Space saving due to horizontal design
Integrated crane eyes
Non-slip terminals

Applications

Isolating transformer for the safe electrical isolation of the input and output sides. The transformer may be used to set up protective separation as a protective measure in accordance with VDE 0100.

As a control transformer for the electrical isolation of the input and output sides. The construction of the transformer to supply control systems according to VDE 0113 is designed.

As a safety isolating transformer for the safe electrical isolation of the input and output sides. The transformer is suitable for creating SELV and PELV circuits because of the limit on the output voltage.

Sample application

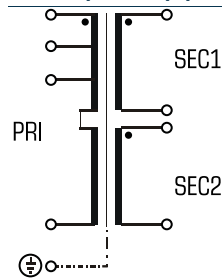

Standards

Control transformer
to: VDE 0570 Teil 2-2, DIN EN 61558-2-2, EN 61558-2-2, IEC 61558-2-2,
UL 5085-1/-2, CSA 22.2 No.66
Isolating transformer
to: VDE 0570 Part 2-4, DIN EN 61558-2-4, EN 61558-2-4, IEC 61558-2-4,
UL 5085-1/-2, CSA 22.2 No.66

Approvals



UL 5085, CSA 22.2 (E 103521)



Control- and isolating transformer

TT1 1-4-23

Type		TT1 1-4-23
Electrical data	Input	
	Rated input current	2.9 A/2.7 A/2.6 Aac
	Rated input voltage	380/400/420 Vac
	Rated frequency	50 - 60 Hz
	Output	
	Rated output current	4.3 Aac
	Rated output voltage	2 x 115 Vac
	Rated power VDE (DB cos phi=1)	1,000 VA
	Rated power VDE (KB cos phi=0.5)	2,270 VA
	Short circuit voltage uK	ca. 7.2%
	Vector group	iii0
	Efficiency	92%
	Standards	
	Classification	Control- and isolating transformer
	Approvals	
Approvals	cURus	
Environment		
Ambient temperature max.	104.0 °F	
Type of cooling	AN	
Safety and protection		
Insulation class	VDE=F, UL=class 155	
Protection index	IP 00 IPXXB on request	
Safety class (prepared)	I	
Type	Open type	
Short circuit strength	non-short-circuit proof	
Order numbers		
Order Number	TT1 1-4-23	

Type		TT1 1-4-23
Mechanical data	Terminal and mounting	
	Fixing method	Fixing rail
	Fixing screws	M6
	Terminals	Screw-type terminal
	Measures and weights	
	Core type	UI 114/40
	Weight	20.06 lbs
	Dimensions in inch	

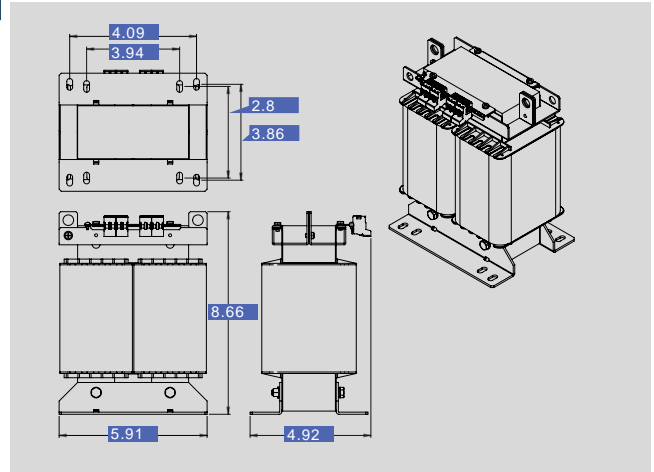

Subject to change.