

# Control- and isolating transformer TT1 4-5-23



Picture shows TT1 20-4/23

## Advantages

Safe galvanic isolation
Patented assembly technology
Very good corrosion protection and low noise due to vacuum impregnation
Primary side $\pm 5\%$ taps for voltage adjustment
Fixed, contact protected screw connection terminals complying with UVV BGV A3
Multiple mounting dimensions
Space saving due to horizontal design
Integrated crane eyes
Non-slip terminals

## Applications

Isolating transformer for the safe electrical isolation of the input and output sides. The transformer may be used to set up protective separation as a protective measure in accordance with VDE 0100.

As a control transformer for the electrical isolation of the input and output sides. The construction of the transformer to supply control systems according to VDE 0113 is designed.

As a safety isolating transformer for the safe electrical isolation of the input and output sides. The transformer is suitable for creating SELV and PELV circuits because of the limit on the output voltage.

## Sample application

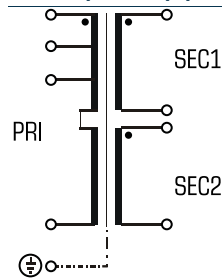

## Standards

Control transformer  
to: VDE 0570 Teil 2-2, DIN EN 61558-2-2, EN 61558-2-2, IEC 61558-2-2,  
UL 5085-1/-2, CSA 22.2 No.66  
Isolating transformer  
to: VDE 0570 Part 2-4, DIN EN 61558-2-4, EN 61558-2-4, IEC 61558-2-4,  
UL 5085-1/-2, CSA 22.2 No.66

## Approvals



UL 5085, CSA 22.2 (E 103521)



# Control- and isolating transformer

## TT1 4-5-23

### Electrical data

Type	TT1 4-5-23
<b>Input</b>	
Rated input current	8.9 A/8.4 A/8.0 Aac
Rated input voltage	475/500/525 Vac
Rated frequency	50 - 60 Hz
<b>Output</b>	
Rated output current	17.4 Aac
Rated output voltage	2 x 115 Vac
Rated power VDE (DB cos phi=1)	4,000 VA
Rated power VDE (KB cos phi=0.5)	12,450 VA
Short circuit voltage uK	ca. 4.1%
Vector group	iii0
Efficiency	95 %
<b>Standards</b>	
Classification	Control- and isolating transformer
<b>Approvals</b>	
Approvals	cURus
<b>Environment</b>	
Ambient temperature max.	104.0 °F
Type of cooling	AN
<b>Safety and protection</b>	
Insulation class	VDE=F, UL=class 155
Protection index	IP 00 IPXXB on request
Safety class (prepared)	I
Type	Open type
Short circuit strength	non-short-circuit proof
<b>Order numbers</b>	
<b>Order Number</b>	<b>TT1 4-5-23</b>

### Mechanical data

Type	TT1 4-5-23
<b>Terminal and mounting</b>	
Fixing method	Fixing rail
Fixing screws	M10
Terminals	Screw-type terminal
<b>Measures and weights</b>	
Core type	UI 180/63
Weight	68.34 lbs
<b>Dimensions in inch</b>	

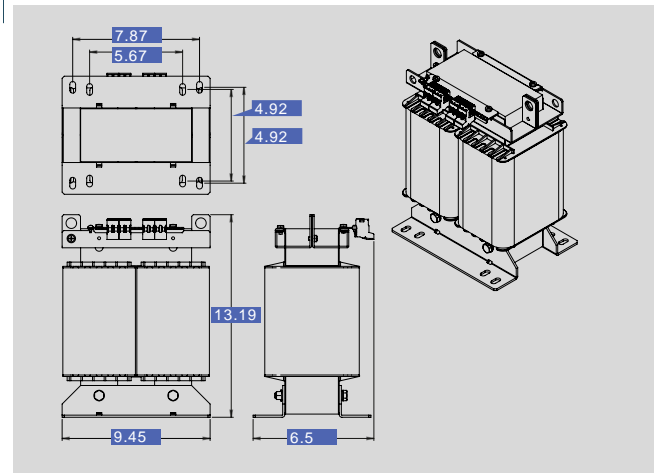

Subject to change.